

PETOL™ -TITAN™ REVERSIBLE CHAIN TONG – C47-P Parts List

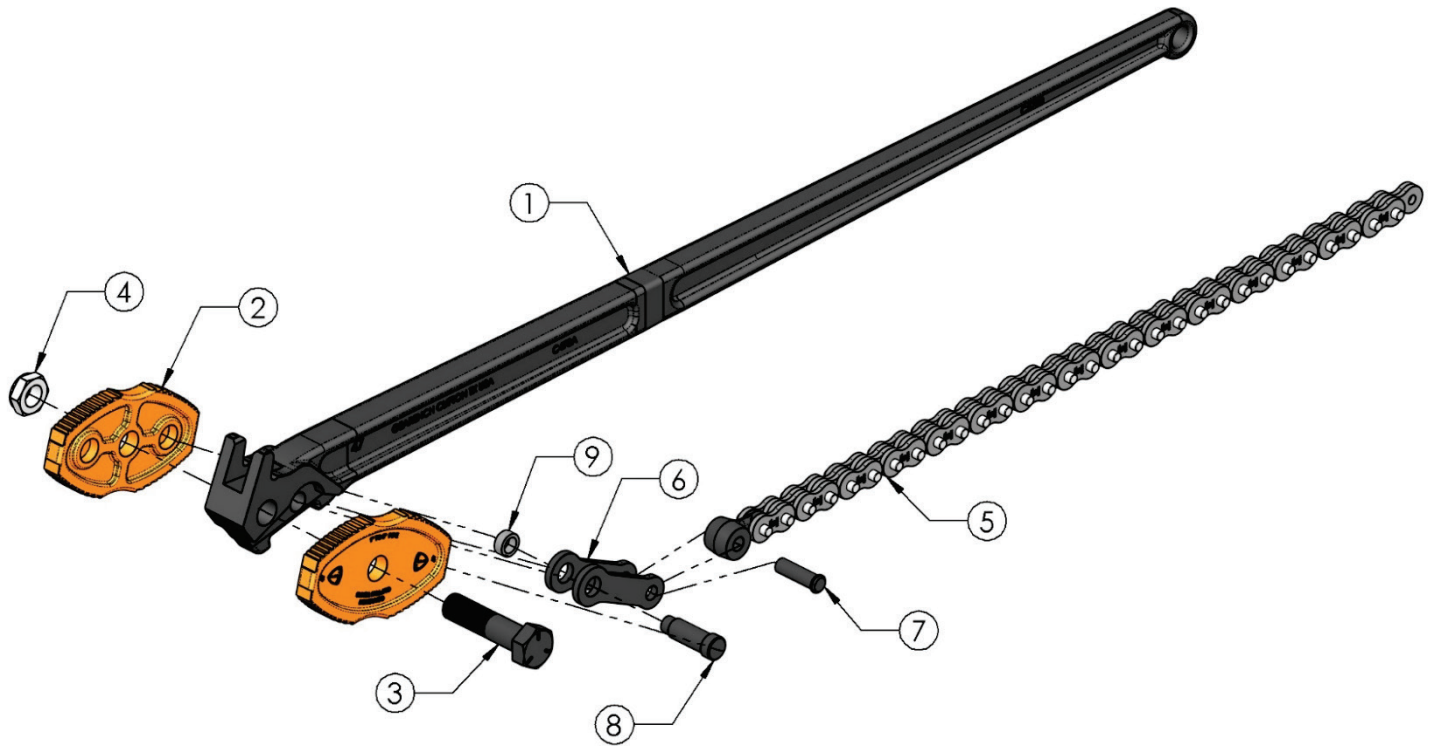

Item	Qty.	Part Number	Description
1	1	C470	Handle
2	1	C471	Jaws (pair)
3	1	HB30	Jaw – handle bolt with nut
4	1	HXN033	Nut only
5	1	*	Chain assembly with master link
6	2	C477	Stirrup link
7	1	HP318	Stirrup link – master link rivet
8	1	HP313	Stirrup link – handle pin
9	1	HU53	Stirrup link – handle bushing

*See Replacement Chain Guides on product web page



4450 S. Hwy. 6 | P.O. Box 192
Clifton, TX 76634 | USA
www.PETOL.com

sales@petol.com | 254.675.8651