

PETOL™ DRILL PIPE TONG™ - DA8184-L28 Parts List

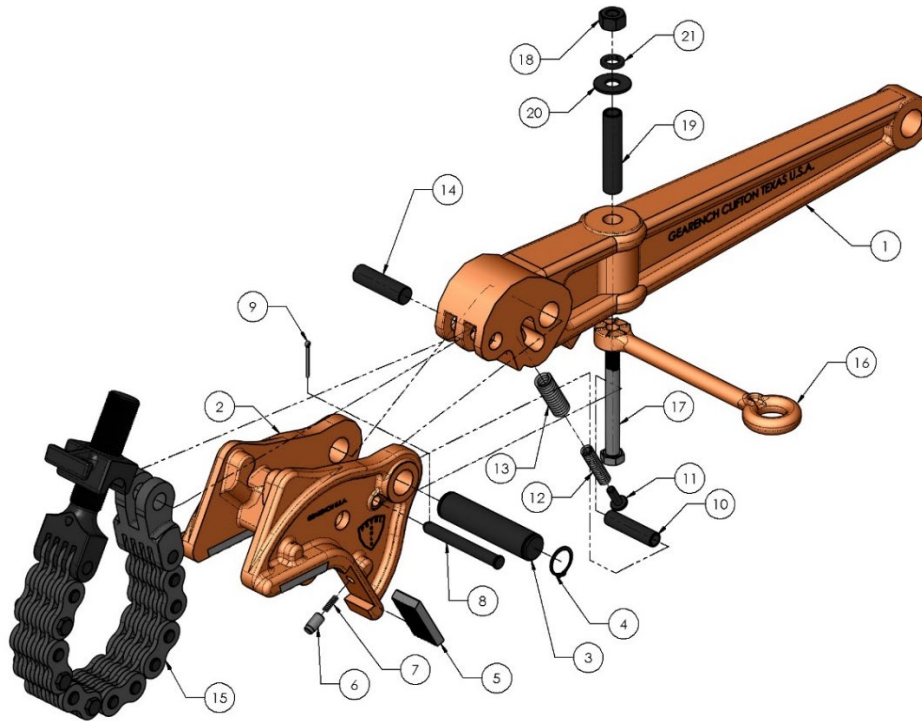

Item	Qty	Part Number	Description
1	1	LH116-L28	Handle
2	1	DJ8184	Jaw
3	1	HP249	Jaw – handle pin with retaining rings
4	4	HXRR150	Jaw pin retaining ring only
5	4	HI09D	Diamond point insert (standard)
5	4	HI09K	Knurled insert (optional)
6	4	HP904	Insert key
7	4	HS21	Insert key spring
8	1	HP250	Spring pin with cotter
9	1	HXC003	Spring pin cotter only
10	1	HU36	Spring bushing
11	1	HG09	Spring guide
12	1	HS09	Spring (inner)
13	1	HS18	Spring (outer)
14	1	HP234	Master link – handle pin
15	1	*	Chain assembly (see next page for parts)
16	1	HH16	Hanger
17	1	HB19	Hanger bolt with nut
18	1	HXN023	Hanger nut only
19	1	HU49	Hanger bushing
20	1	HXW001	Hanger flat washer
21	1	HXW002	Hanger lock washer

*See Chain Guide on product web page



4450 S. Hwy. 6 | P.O. Box 192
Clifton, TX 76634 | USA
www.PETOL.com

sales@petol.com | 254.675.8651

PETOL™ DRILL PIPE TONG™ - DA8184-L28 Parts List

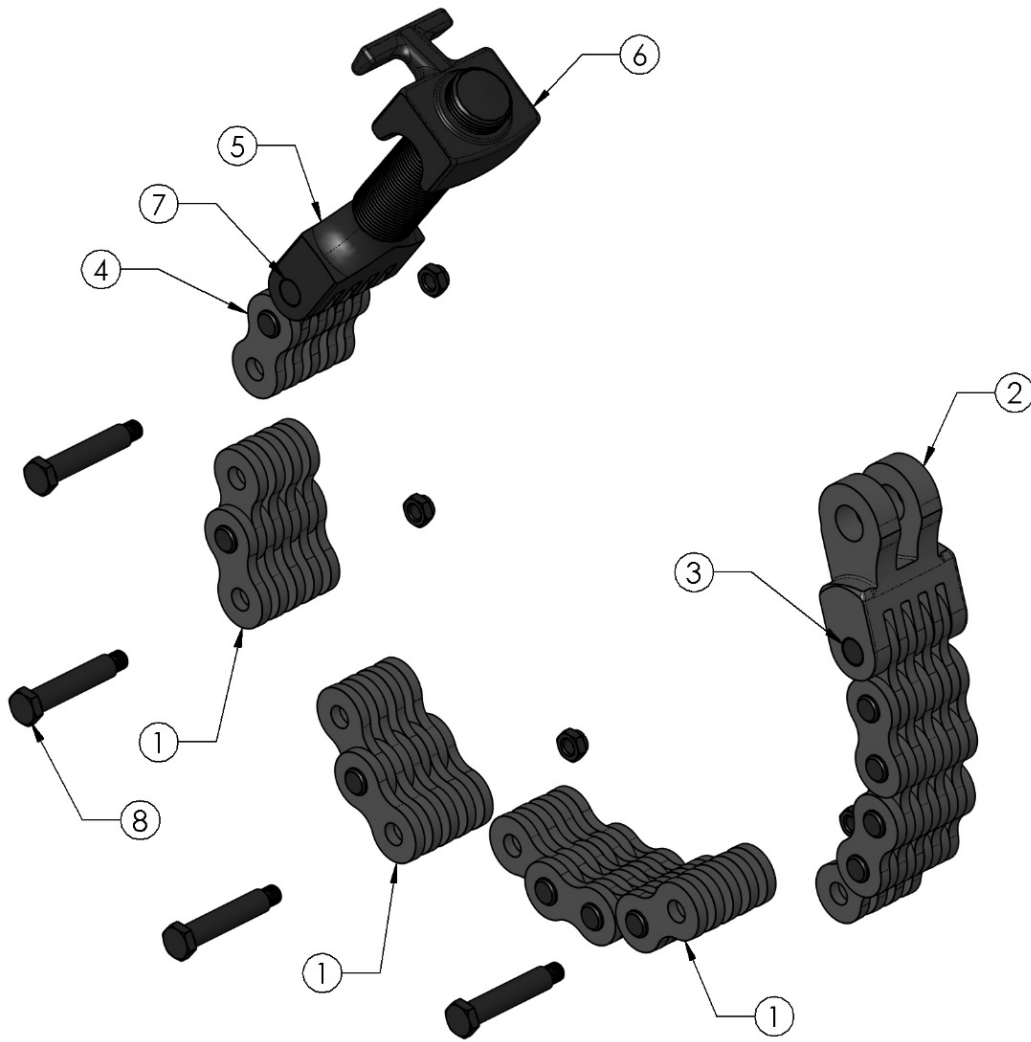

Item	Part Number	Description
1	161-45-02	Special chain only
1	161-45-03	Special chain only
1	161-45-05	Special chain only
1	161-45-07	Special chain only
2	HM06-45	Master link
3	HP247	Master link – chain rivet
4	161-45-02-HV08	Chain screw assembly
4	161-54-03-HV08	Chain screw assembly
5	HV08-45	Chain screw only
5	HV08-54	Chain screw only
6	HN08	Chain screw nut
7	HP247	Chain screw – chain rivet (for HV08-45)
7	HP045	Chain screw – chain rivet (for HV08-54)
8	HB52	Splice bolt and nut
8	HXN016	Splice bolt nut only



4450 S. Hwy. 6 | P.O. Box 192
 Clifton, TX 76634 | USA
www.PETOL.com

sales@petol.com | 254.675.8651